

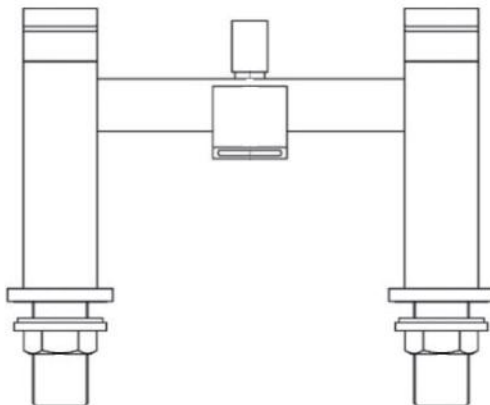

Thank you for choosing Better Bathrooms.  
Please read this manual before installing your product  
and keep for future reference.

**better  
bathrooms**

## Product name Deck Mounted Bath Filler And Bath Shower Mixer



Please note: Image is for illustrative purposes only and may differ slightly to the actual product

- **Single person assembly**
- **Tools required**
- **We always recommend using professional tradespeople to install your product**

# Congratulations on your purchase

*And welcome to our growing gang of savvy shoppers*

We're on a mission to bring you extraordinary bathroom products, for less. From modern to traditional style ceramics, plus the gorgeous fixtures, fittings and furniture to match. So, you can fall in love with your space every single day.

As one of the UK's largest independent bathroom stores, we've received countless awards; including the National Business Awards UK, the Digital Entrepreneur Awards and being placed on The Sunday Times Fast Track 100.

We hope your new product exceeds your highest expectations. However, if you experience any problems, please:

- log in to your account and contact our customer services team via your self-serve portal - [betterbathrooms.com/CustomerAccount/Login](https://betterbathrooms.com/CustomerAccount/Login)
- contact us via [betterbathrooms.com/content/contact-us](https://betterbathrooms.com/content/contact-us)

## Important information

- Please read these instructions thoroughly and retain for future reference.
- Pressures should meet minimum stated on the website
- Pressures must be balanced for optimum performance
- Always check for pipes and cables before drilling
- System must be flushed through prior to installation.

# Guarantee

- Please check our website for individual product guarantee's.
- Some parts of the product, i.e. valve/diverter, are covered by a 12-month guarantee.
- Your guarantee can be invalid if the pre-installation checks are not carried out, installation is not carried out as per this guide, and correct maintenance instructions are not followed. Please see our website for T & C's.

# Parts

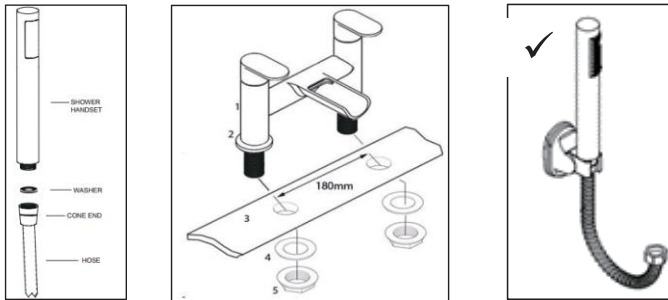

Please note: Image is for illustrative purposes only and may differ slightly to the actual product

1. Deck mixer
2. Base plate x 2 (if provided)
3. Bath (purchased separately)
4. Washer x 2
5. Back nut x 2
- 6.Hose\*1
- 7.Handset\*1
- 8.Washer\*2
- 9.Bracket\*1

# Tools required

- Spanner and Drill

# Installation

**Please note:** Before starting the installation of a new mixer, turn off the water supply

**Please note:** HOT supply to the left and COLD supply to the right

1. Remove back nuts (5) and washers (4) if they are already fitted to the mixer.
2. Place base plates (2) if provided, onto the mixer tails.
3. Place the mixer tails through the tap holes in the bath (3) (which should measure 180mm centre to centre).
4. From underneath the bath, fit the washers (4) and back nuts (5) then tighten into position.
5. Connect to the water supply, making a watertight seal in the process.
6. Turn on the water supply and check for leaks.

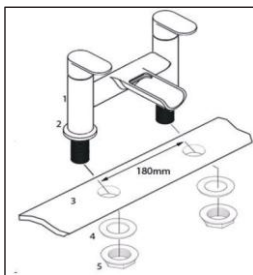

Please note: Image is for illustrative purposes only and may differ slightly to the actual product

## If installing a bath shower mixer with handset and holder

1. Secure the holder to the wall in a position which will allow the hose to hang freely.
2. Fit seals to both end of the hose.
3. Connect cone end of the hose to handset and nut end to mixer outlet and tighten.

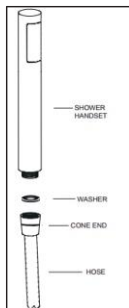

**IMPORTANT:**

Always ensure when fitting a bath shower mixer with a handset holder, that the holder is positioned so as not to put the shower hose under tension.

The hose should hang freely from the mixer outlet (as shown below).

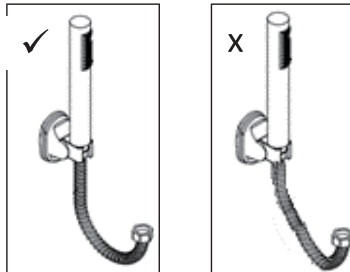

## Troubleshooting

### Mixer drips after being turned off

1. Draining - due to the design of some mixer spouts, water will be held and drip until emptied.
2. Debris inside the valve - remove the valve and flush under running water while turning the spindle.

### Poor water flow

1. Insufficient water pressure - increase water pressure possibly installing a pump.
2. System pressure should meet minimum requirement pre-installation.
3. Blockage - check water is reaching the mixer, check valve, mixer tails and supply pipes.
4. Isolation valves not fully opened.

### Water not mixing

1. Hot and Cold supplies not balanced - increase or decrease pressures to balance. (Always maintain the minimum pressure requirement)
2. Blockage - check water is reaching the mixer, check valve, mixer tails and supply pipes.

## Mixer not diverting correctly (If a lift and drop type diverter)

1. Insufficient water pressure - increase water pressure possibly installing a pump.
5. System pressure should meet minimum requirement pre-installation.
2. Your mixer may be a twist and lock diverter - lift the handle, pull and twist to lock into position.

# Maintenance

## Valve removal for various designs

**IMPORTANT:** Ensure to turn off the water supply to the mixer prior to any maintenance

**Please note:** Design may vary from those shown below

### Design A

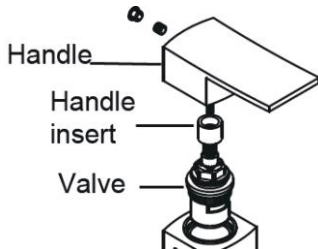

1. Remove screw cap cover.  
(This could be at front or back of handle)
2. Loosen grub screw using a hex key.
3. Pull handle from the mixer.
4. Remove insert (If included in your product).
5. Using a spanner, remove the valve.
6. Carry out maintenance.
7. Replace valve and tighten.
8. Replace all components.

### Design B

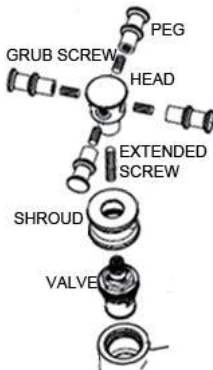

1. Unscrew all handle pegs
2. Remove grub screws using a hex key
3. Pull head section from the mixer
4. Remove extended screw
5. Unscrew shroud
6. Using a spanner remove the valve
7. Carry out maintenance.
8. Replace valve and tighten.
9. Replace all components.

## Design C

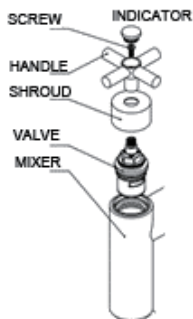

1. Remove H or C indicator
2. Using a screwdriver remove handle screw
3. Pull handle from the mixer
4. Unscrew shroud
5. Using a spanner remove the valve
6. Carry out maintenance
7. Replace valve and tighten
8. Replace all components

## Design D

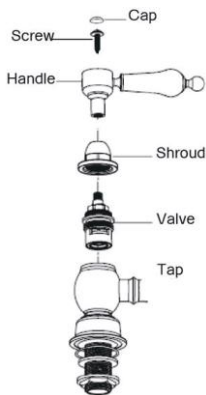

1. Remove H or C indicator
2. Using a screwdriver remove handle screw
3. Pull handle from the mixer
4. Unscrew shroud
5. Using a spanner remove the valve
6. Carry out maintenance
7. Replace valve and tighten
8. Replace all components

## Cleaning

To maintain the surface finish of your product, wipe clean regularly, using a clean damp cloth and dry cloth to polish. Do not use abrasive cleaning agents or materials on the product surface as you may invalidate your guarantee. Should any harsh chemicals come into contact with the surface of the product during bathroom cleaning, rinse off immediately, wipe clean and dry.

### For more information

- visit [betterbathrooms.com](http://betterbathrooms.com)
- email [customerservices@buyitdirect.co.uk](mailto:customerservices@buyitdirect.co.uk)
- call 0330 390 3062
- write to Trident Business Park, Neptune Way, Huddersfield, HD2 1UA

**better  
bathrooms**

Part of the BuyItDirect Group